

THIRD ANGLE PROJECTION

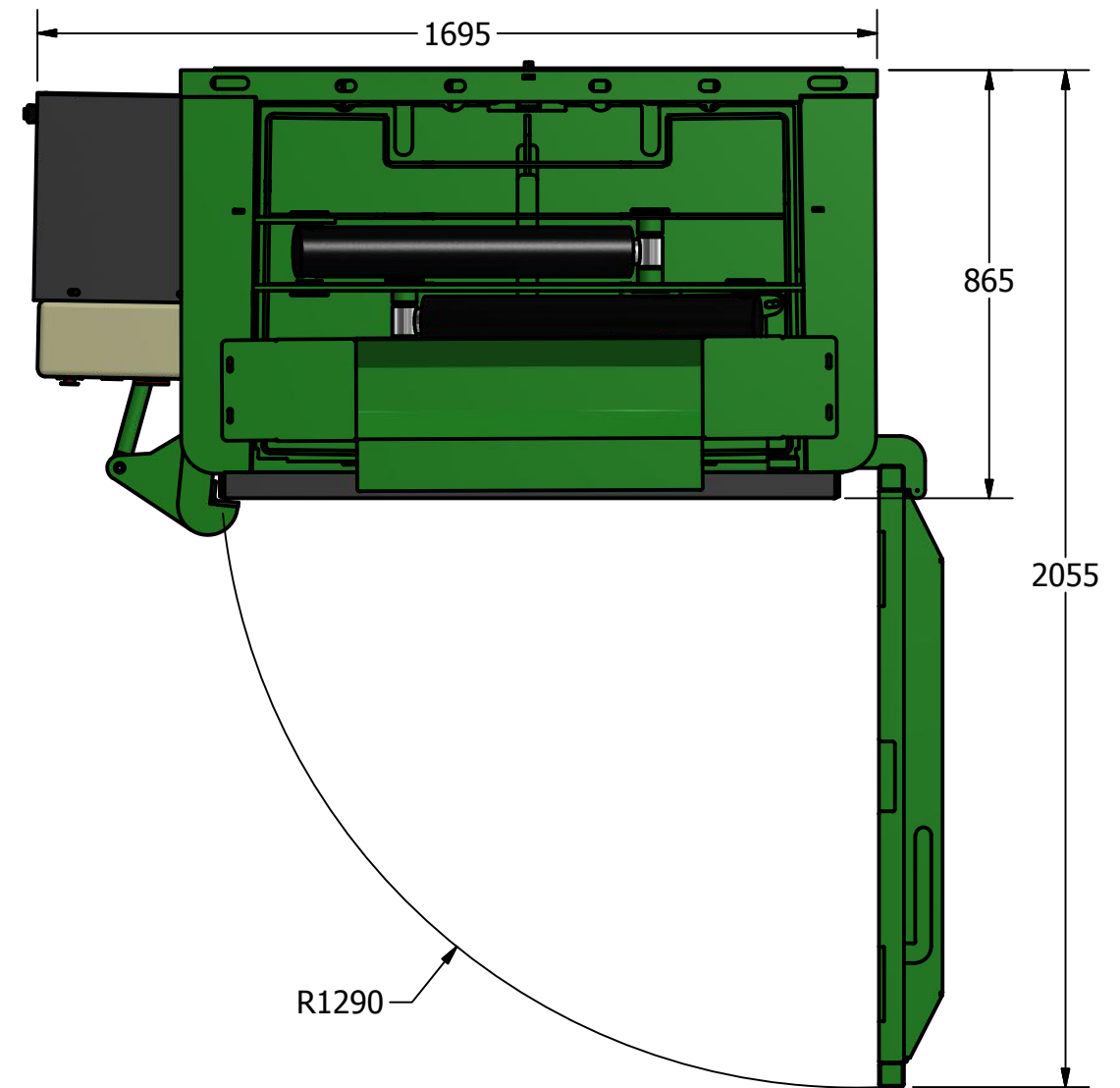
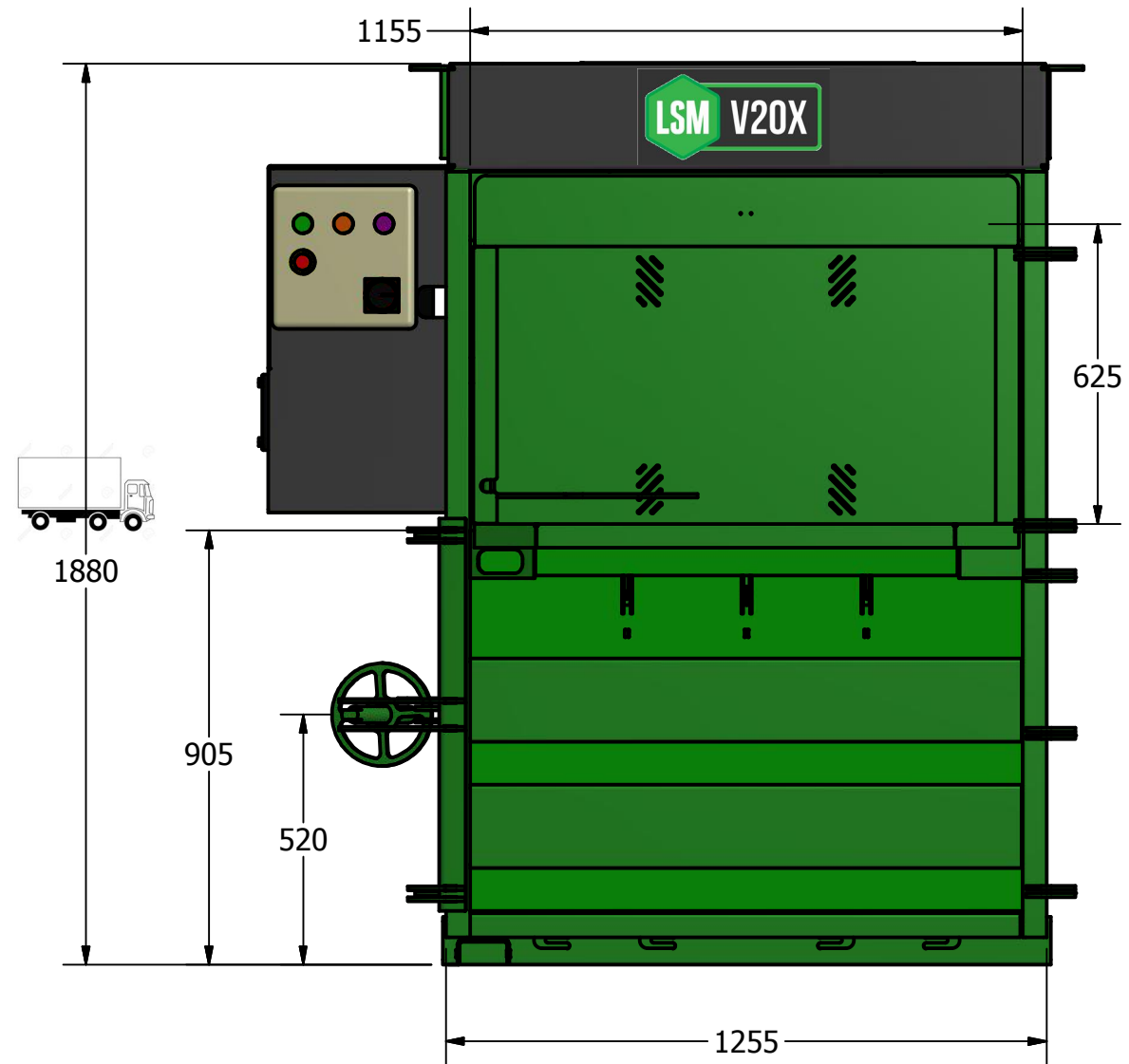
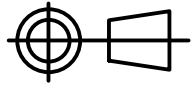

WWW.LSMLTD.COM

MODEL CODE	V20X
MACHINE WEIGHT	965 Kg
NOISE LEVEL	74 dB